

Tagventilator CRDV-T 200 - 315



Korrosionsbestandige radialventilatorer for transport af aggressive gasser og luftarter

Ventilatorstørrelser

Tallet efter CDRV-T refererer til størrelsen på indløbets diameter i mm.

CRDV-T serien går fra 250 mm til 315 mm indløbsdiameter.

Tekniske data:

Ydelse: max 5.200 m³/h

Statisk tryk: max 1.700 Pa

Virkningsgrad: max 75%



Ventilatorhuset

Vakuumformet i termoplast i PPs og PPs el.

Ventilatorhuset er udformet således af motoren er placeret uden for luftstrømmen.

Ventilatorhjul

Sprøjtstøbt F-hjul med 20 fremverbøjet skovle i PPs, PPs el eller PVDF.

Ventilatorhjulets nav er støbt aluminium med en krave som forstærkning, der giver stor sikkerhed ved høje rotationshastigheder.

Hvert ventilatorhjul er dynamisk afbalanceret i to planer efter VDI 2060 GS Q 6,3.

Drivform

CRDV-T leveres med direkte drevet IEC B5 normmotor i 3- eller 1-faset version.

Omdrejningsregulering

CRDV-T kan leveres med en- eller tohastigheds-motor. Standardmotoren kan omdrejningsreguleres med frekvensomformer.

BONI ventilation kan levere CRDV-T med bl.a. frekvensstyret el-motor fra Grundfos.

Tilbehør

Se vores leveringsprogram af tilbehør i afsnittet tilbehør.



Kan leveres til ATEX zone 1 og 2.

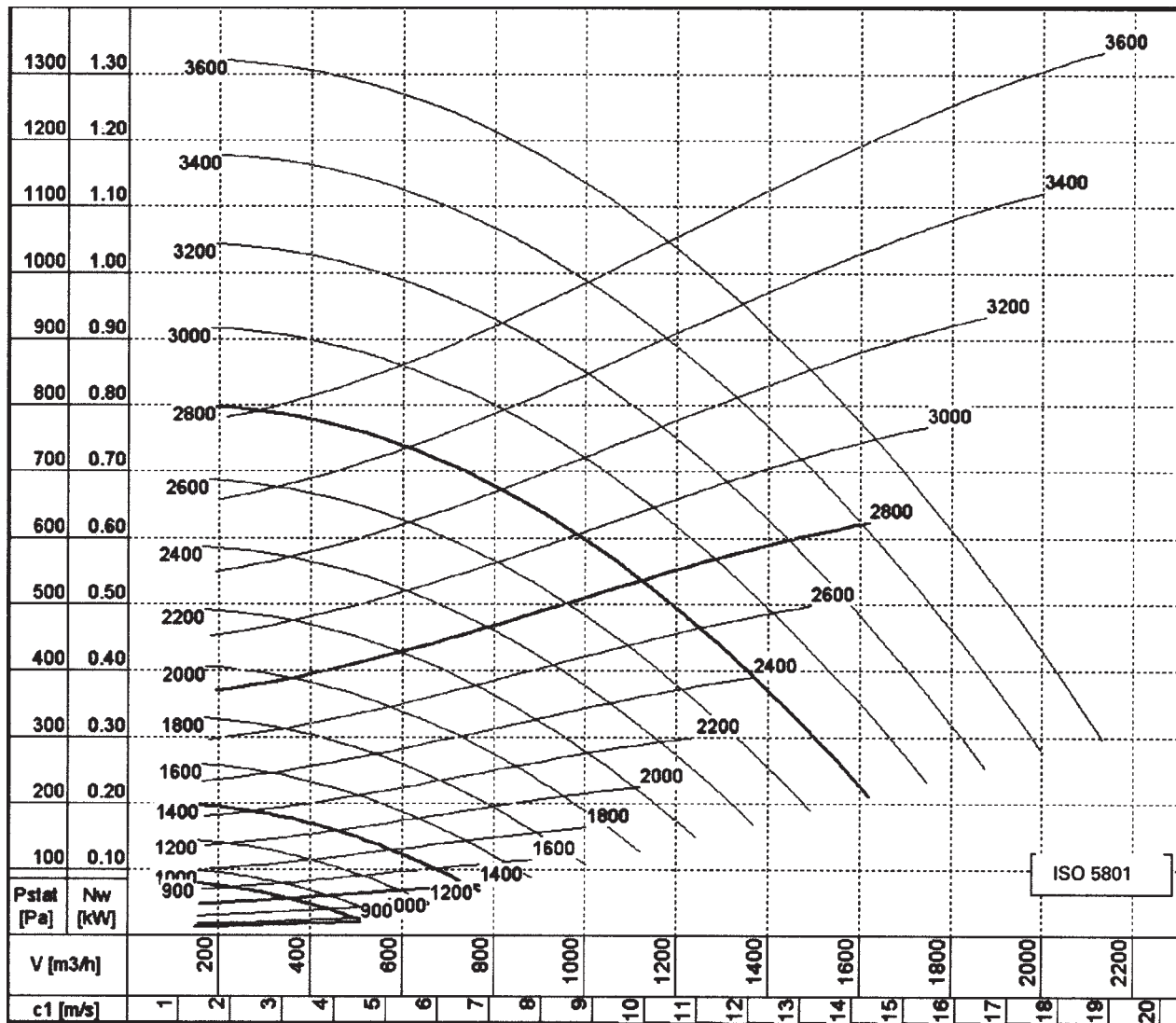

Lydniveau	Lw	Lydtryk							
	dB(A)	Lp _A =Lw _A -7dB(A) I en afstand på 1m.							
n	Lw	Hz							
min -1	dB(A)	63	125	250	500	1000	2000	4000	8000
700	46	20	32	40	43	39	35	28	19
850	51	25	37	45	58	44	40	33	24
900	52	26	38	46	49	45	41	34	25
1100	56	30	42	50	53	49	45	38	29
1400	61	35	47	55	58	54	50	43	34
1700	65	39	51	59	62	58	54	47	38
2800	76	50	62	70	73	69	65	58	49
3400	80	54	66	74	77	73	69	62	53
3600	81	55	67	75	78	74	70	63	54

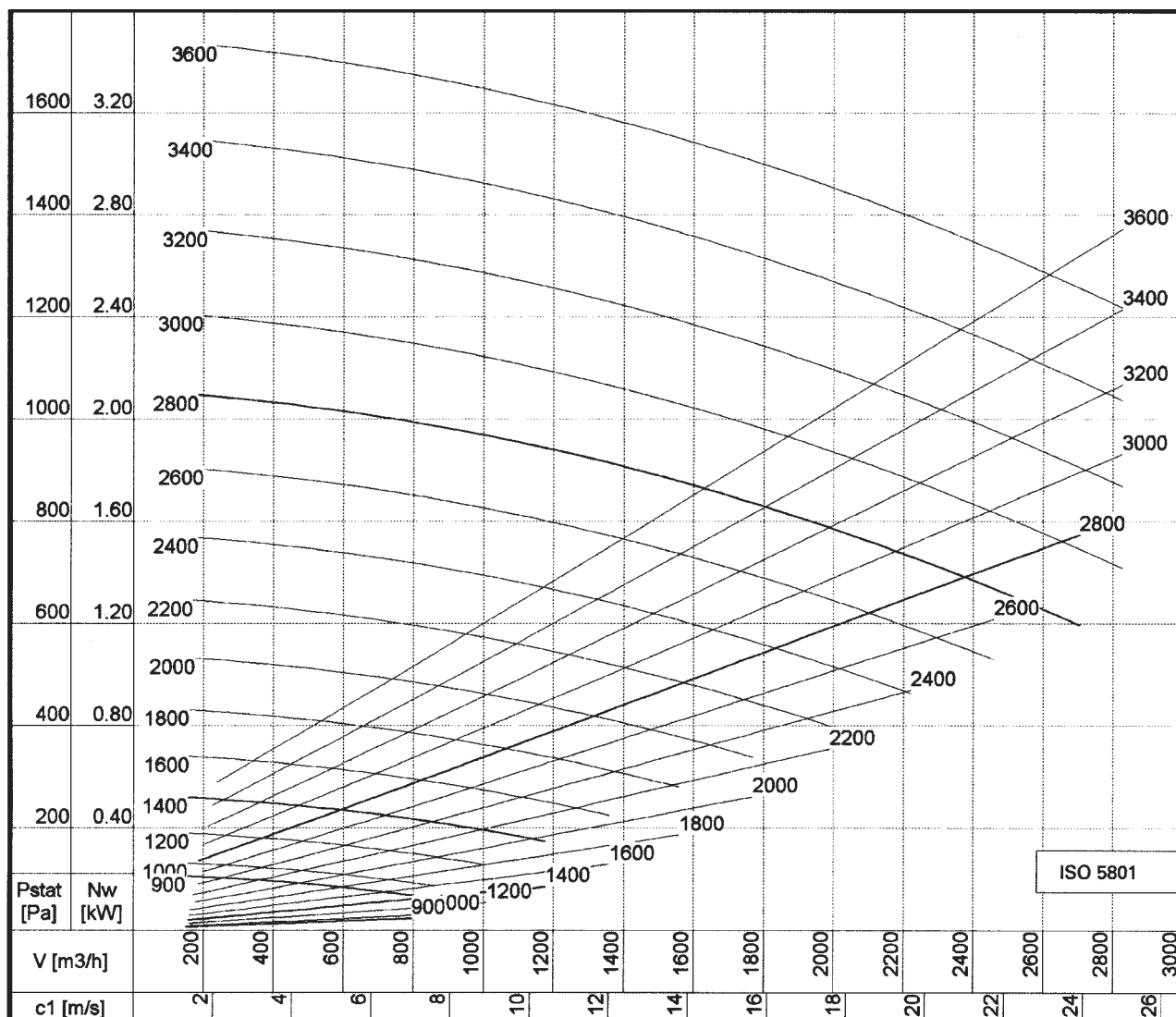

Lydniveau	Lw dB(A)	Lydtryk					Lp _A =Lw _A -7dB(A)				I en afstand på 1m.
n	Lw	Hz									
min -1	dB(A)	63	125	250	500	1000	2000	4000	8000		
700	47	11	33	39	40	42	39	30	21		
850	52	16	38	44	45	47	44	35	26		
900	53	17	39	45	46	48	45	36	27		
1100	57	21	43	49	50	52	49	40	31		
1400	62	26	48	54	55	57	54	45	36		
1700	66	30	52	58	59	61	58	49	40		
2800	77	41	63	69	70	72	69	60	51		
3400	81	45	67	73	74	76	73	64	55		
3600	82	46	68	74	75	77	74	65	56		

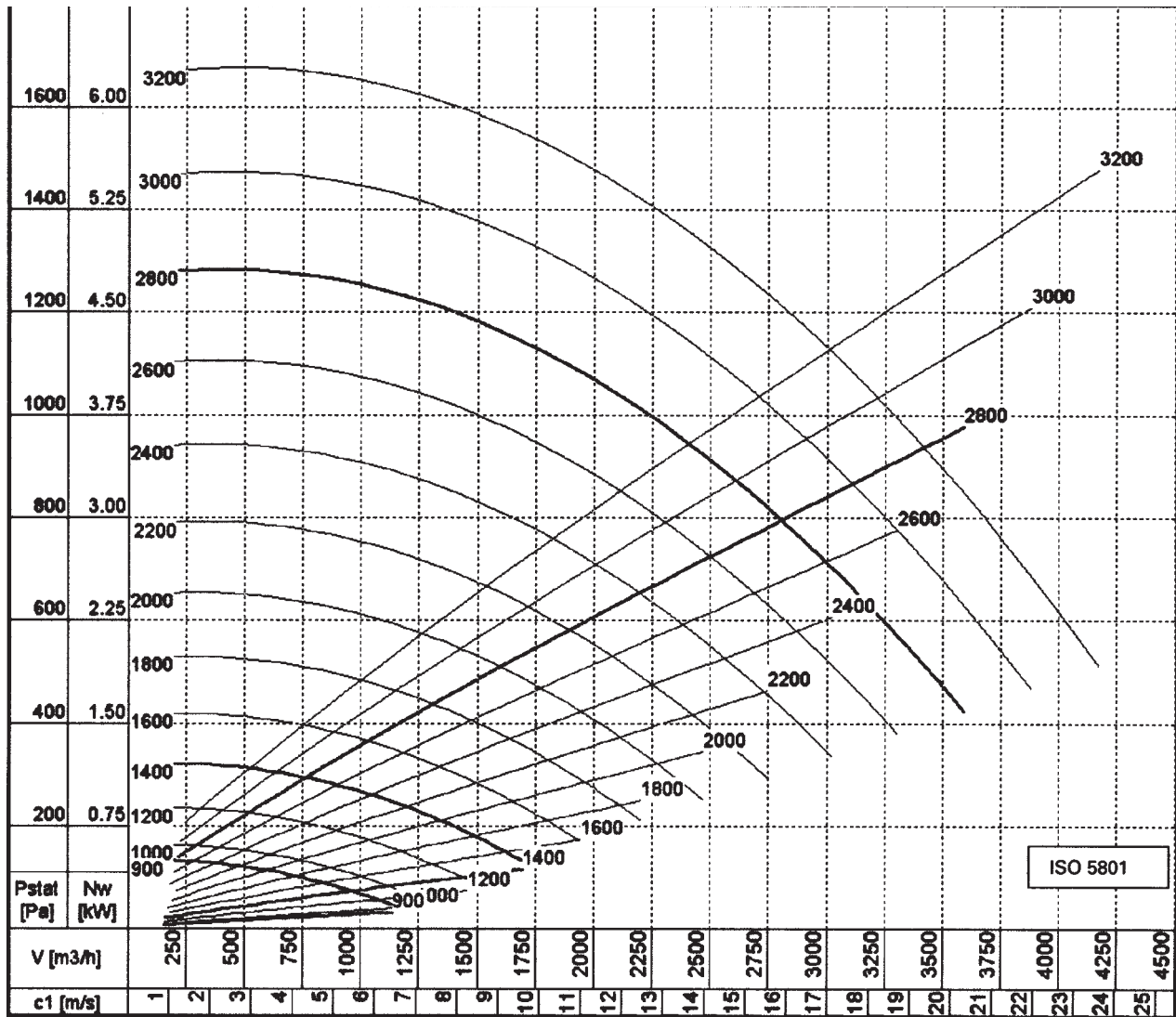

Lydniveau	Lw	dB(A)		Lydtryk	Lp _A =Lw _A -7dB(A)		I en afstand på 1m.			
n	Lw	Hz								
min -1	dB(A)	63	125	250	500	1000	2000	4000	8000	
700	49	18	32	41	44	45	42	33	23	
850	54	23	37	46	49	50	47	38	28	
900	55	24	38	47	50	51	48	39	29	
1100	59	28	42	51	54	55	52	43	33	
1400	64	33	47	56	59	60	57	48	38	
1700	68	37	51	60	63	64	61	52	42	
2800	79	48	62	71	74	75	72	63	53	
3200	81	50	64	73	76	77	74	65	55	

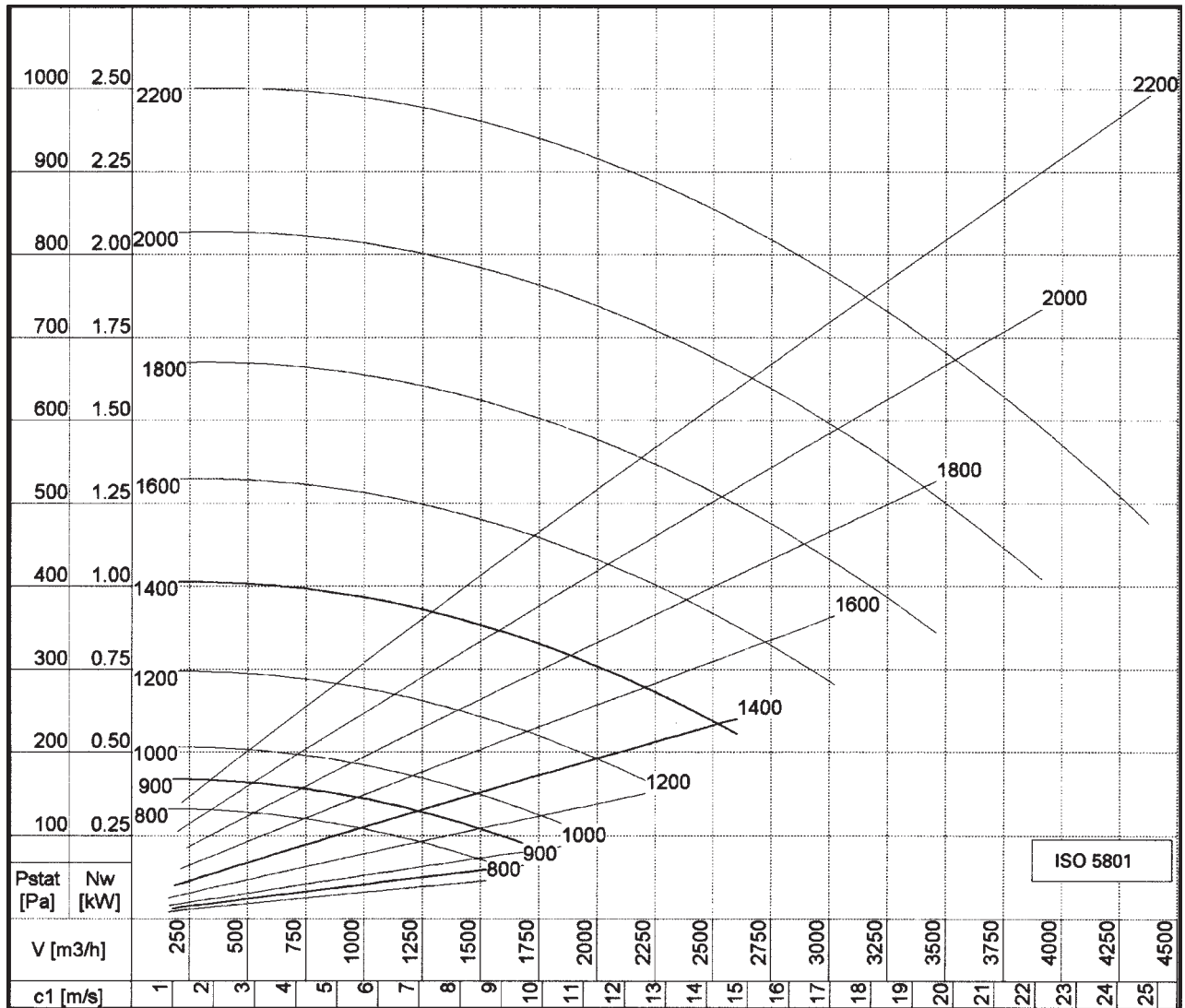

Lydniveau	Lw dB(A)	Lydtryk					I en afstand på 1m.			
n	Lw	Hz								
min -1	dB(A)	63	125	250	500	1000	2000	4000	8000	
700	53	22	38	46	48	49	44	36	26	
850	58	27	43	51	53	54	49	41	31	
900	59	28	44	52	54	55	50	42	32	
1100	63	32	48	56	58	59	54	46	36	
1400	68	37	53	61	63	64	59	51	41	
1700	72	41	57	65	67	68	63	55	45	
2200	77	46	62	70	72	73	68	60	50	

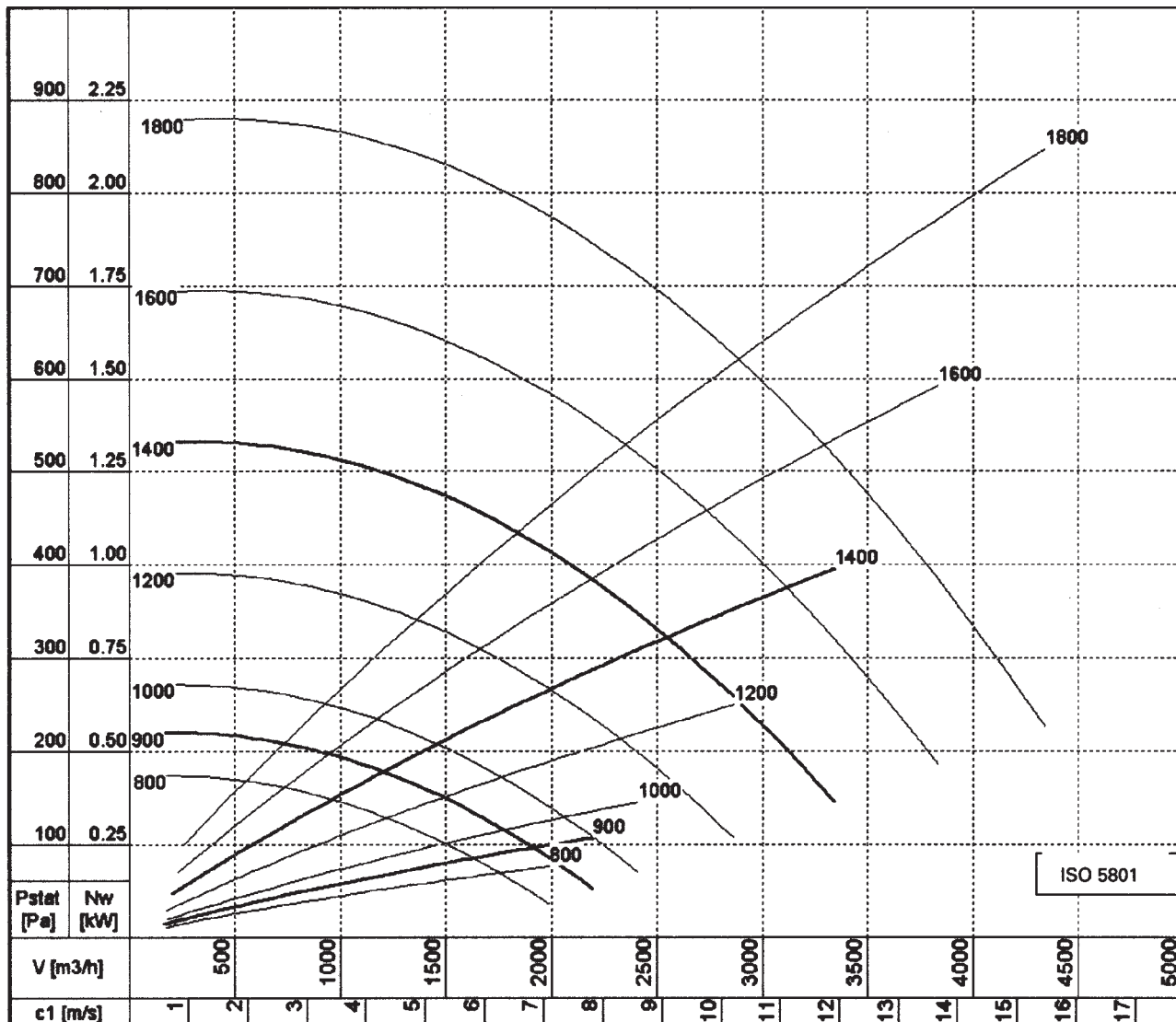

Lydniveau	Lw	Lydtryk					Lp _A =Lw _A -7dB(A)			
n	Lw	Hz								
min -1	dB(A)	63	125	250	500	1000	2000	4000	8000	
700	57	33	42	49	52	52	48	40	31	
850	62	38	47	54	57	57	53	45	36	
900	63	39	48	55	58	58	54	46	37	
1100	67	43	52	59	62	62	58	50	41	
1400	72	48	57	64	67	67	63	55	49	
1700	76	52	61	68	71	71	67	59	50	
1800	77	53	62	69	72	72	68	60	51	

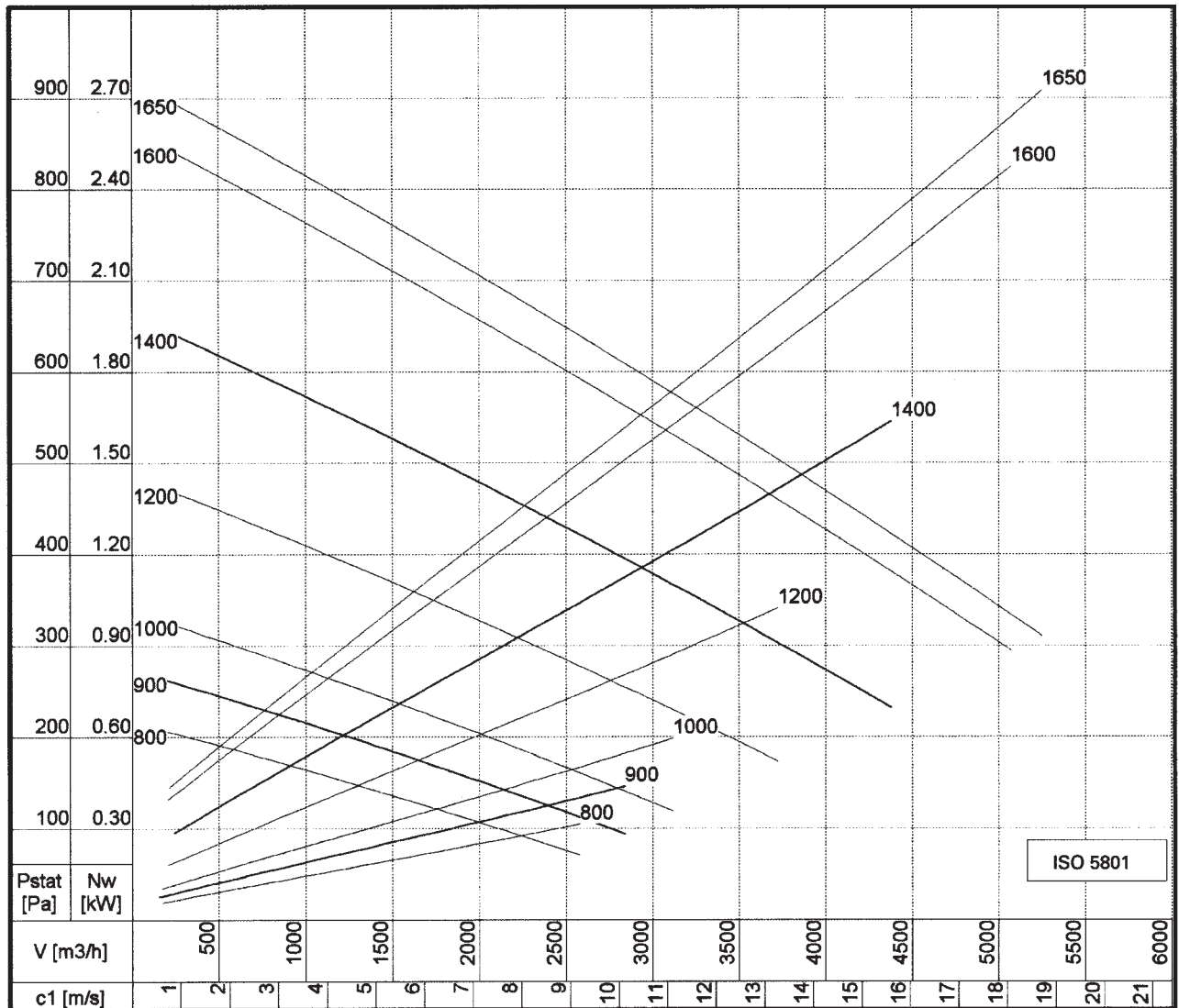

Lydniveau	Lw dB(A)	Lydtryk				Lp _A =Lw _A -7dB(A)				I en afstand på 1m.
n	Lw	Hz								
min -1	dB(A)	63	125	250	500	1000	2000	4000	8000	
700	61	30	44	57	53	56	52	45	34	
850	66	35	49	62	58	61	57	50	39	
900	67	36	50	63	59	62	58	51	40	
1100	71	40	54	67	63	66	62	55	44	
1400	76	45	59	72	68	71	67	60	49	
1650	79	48	62	75	71	74	70	63	52	

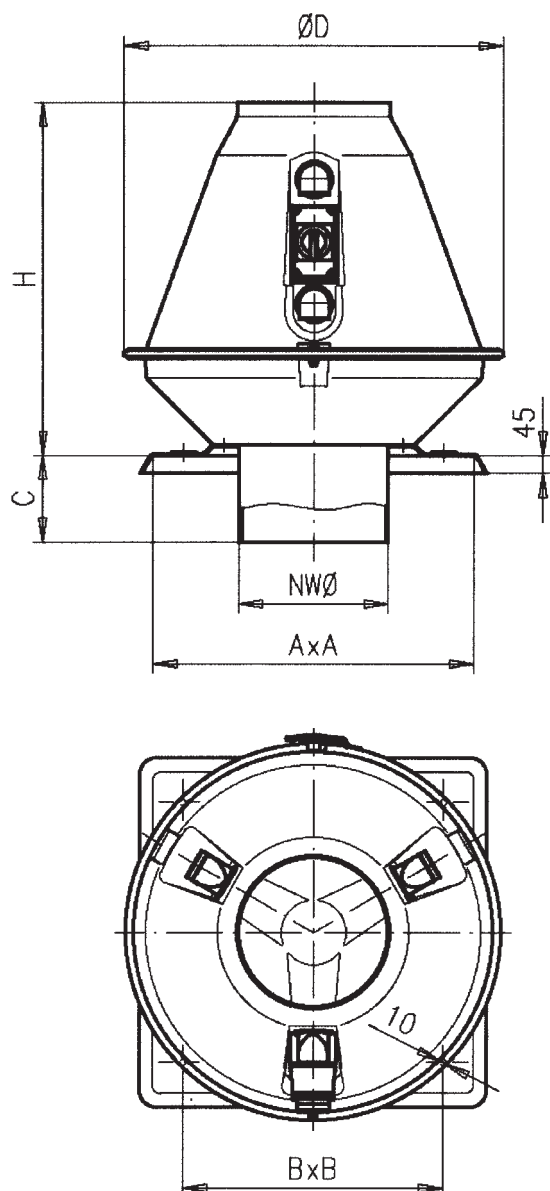

Ventilator Typ CRDV						
	NW \varnothing	A	B	C	$\varnothing D$	H
200D	200	495	400	100	575	575
250D	250	535	435	144	635	590
315D	315	625	520	194	705	615