

Tagventilator

CDVA 400 - 710

Korrosionsbestandige radialventilatorer for transport af aggressive gasser og luftarter

Ventilatorstørrelser

Tallet efter CDVA refererer til størrelsen på indløbets diameter i mm.

CDVA serien går fra 400 mm til 710 mm indløbsdiameter.

Tekniske data:

Ydelse: max 17.000 m³/h
Statisk tryk: max 500 Pa
Virkningsgrad: max 70%

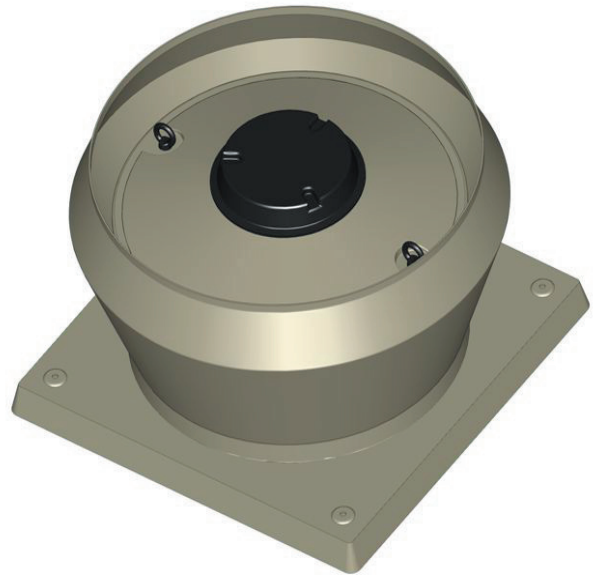

Ventilatorhuset

Er fremstillet i glasfiberarmeret polyester.

Ventilatorhjul

Ventilatorhjulet er udført i PP og er forsynet med 14 eller 20 skovle der har 3 forskellige vinkler.

Drivform

CDVA kan leveres direkte drevet med IEC B5 normmotor i 3- eller 1-faset version.

Omdrejningsregulering

CDVA kan leveres med en- eller to-hastigheds-motor. Standardmotoren kan omdrejningsreguleres med frekvensomformer.

BONI ventilation kan levere CDVA med bl.a. frekvensstyret el-motor fra Grundfos.

Tilbehør

Se vores leveringsprogram af tilbehør i afsnittet tilbehør.

Ydelseskurve for ventilator type

CDVA 400/30

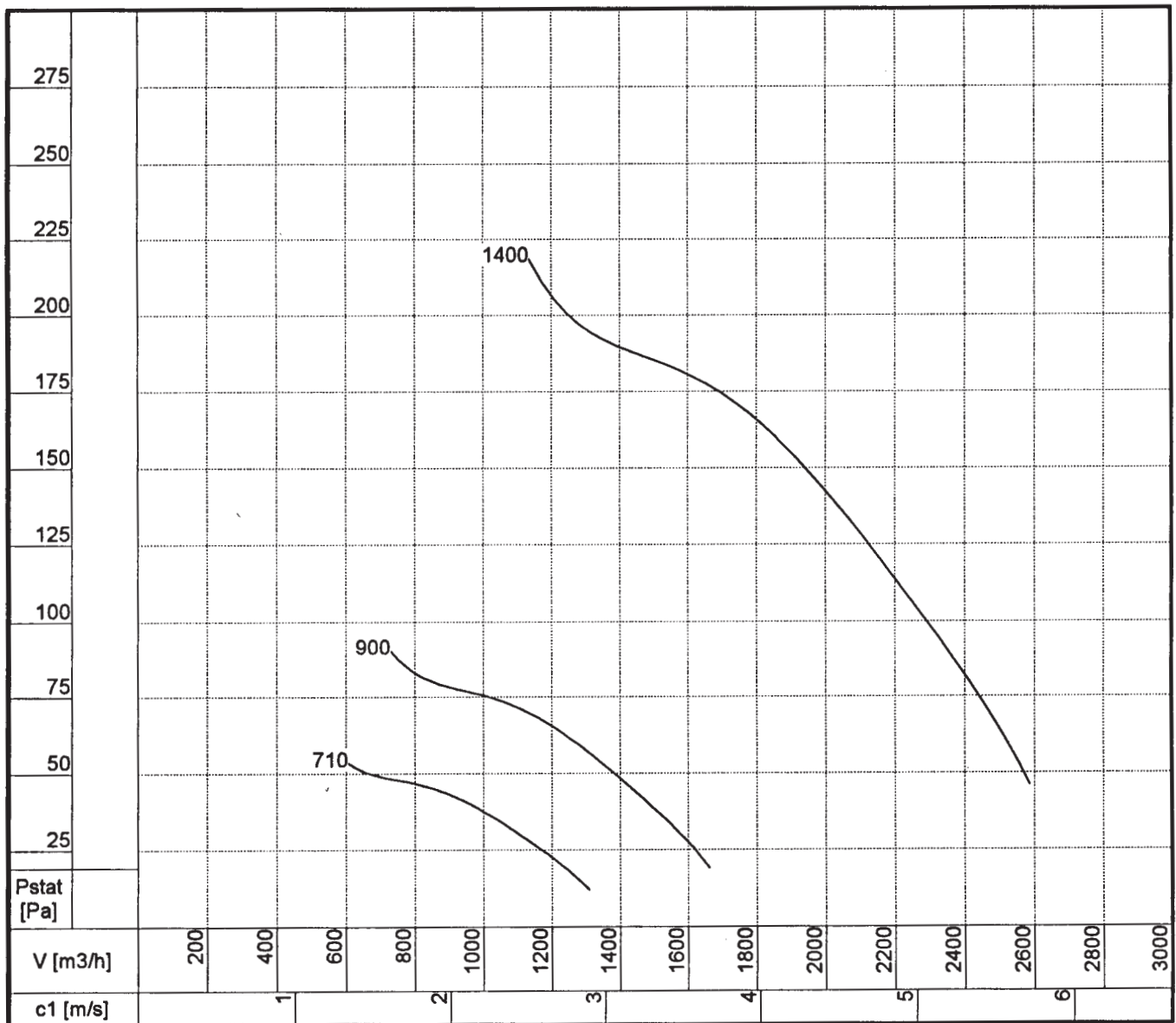

Lydniveau Lw dB Lydtryk Lp=Lw -7dB I en afstand på 1m.

n	Lw	Hz							
min -1	dB	63	125	250	500	1000	2000	4000	8000
700	58	36	45	52	53	52	50	46	42
900	64	42	51	58	59	58	56	52	48
1400	73	51	60	67	68	67	65	61	57

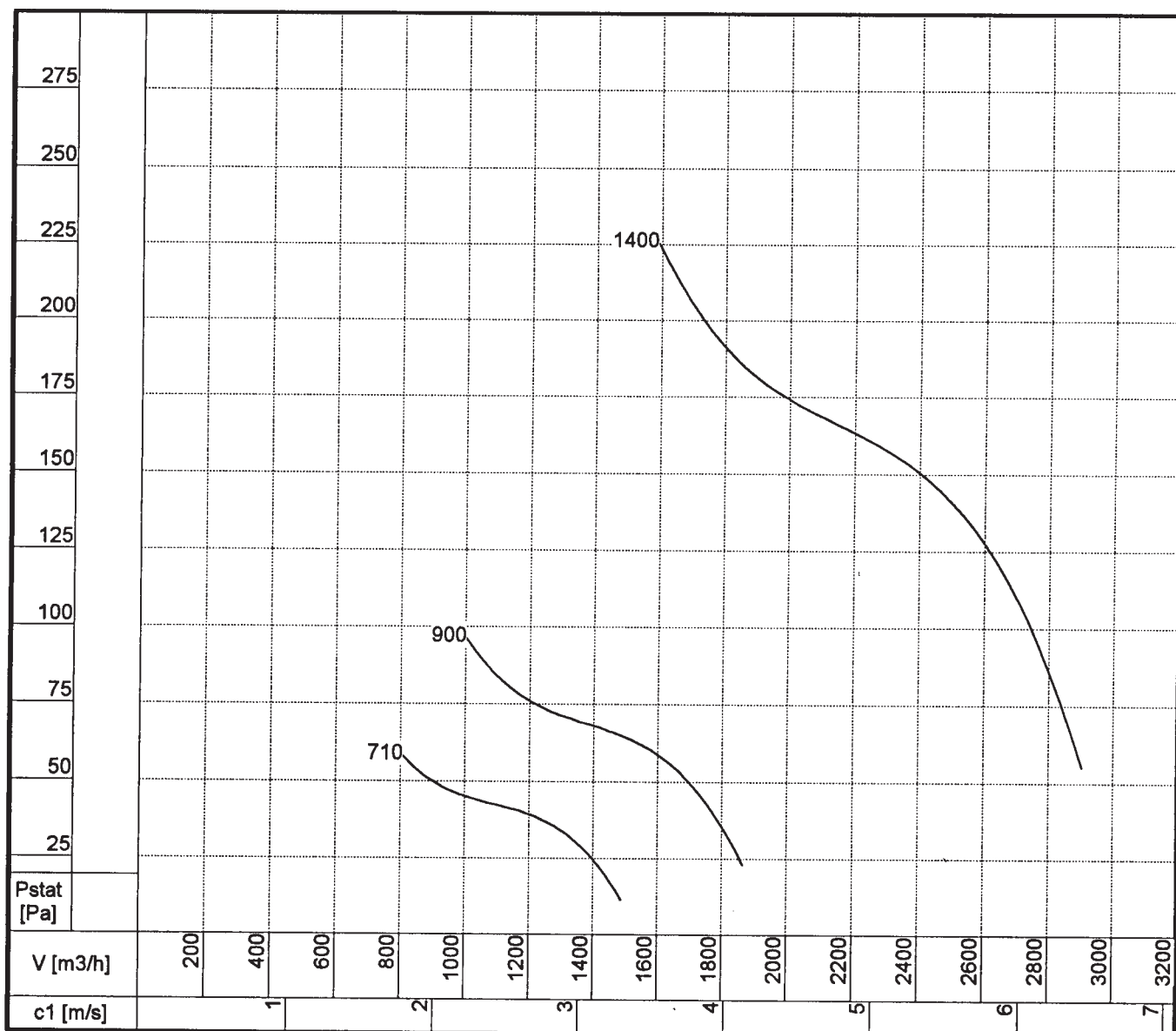

Lydniveau Lw dB Lydtryk Lp=Lw -7dB I en afstand på 1m.

n	Lw	Hz							
min -1	dB	63	125	250	500	1000	2000	4000	8000
700	60	37	46	53	55	53	51	47	43
900	66	43	52	59	61	59	57	53	48
1400	75	52	61	68	70	68	66	62	58

Ydelseskurve for ventilator type

CDVA 400/45

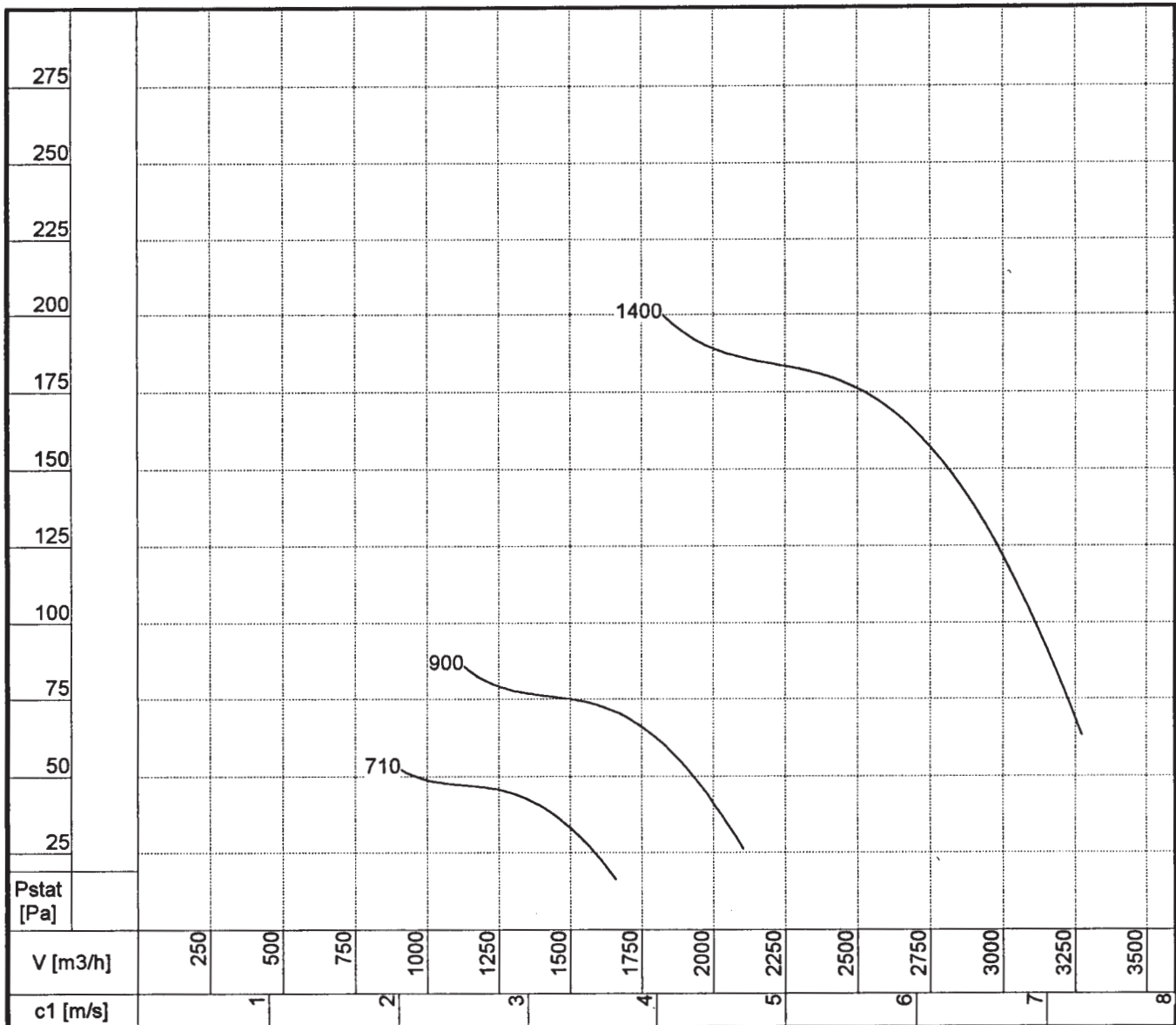

Lydniveau Lw dB Lydtryk Lp=Lw -7dB I en afstand på 1m.

n	Lw	Hz							
min -1	dB	63	125	250	500	1000	2000	4000	8000
700	61	38	48	54	56	54	52	48	44
900	67	44	54	60	62	60	58	54	50
1400	76	53	63	69	71	69	67	63	59

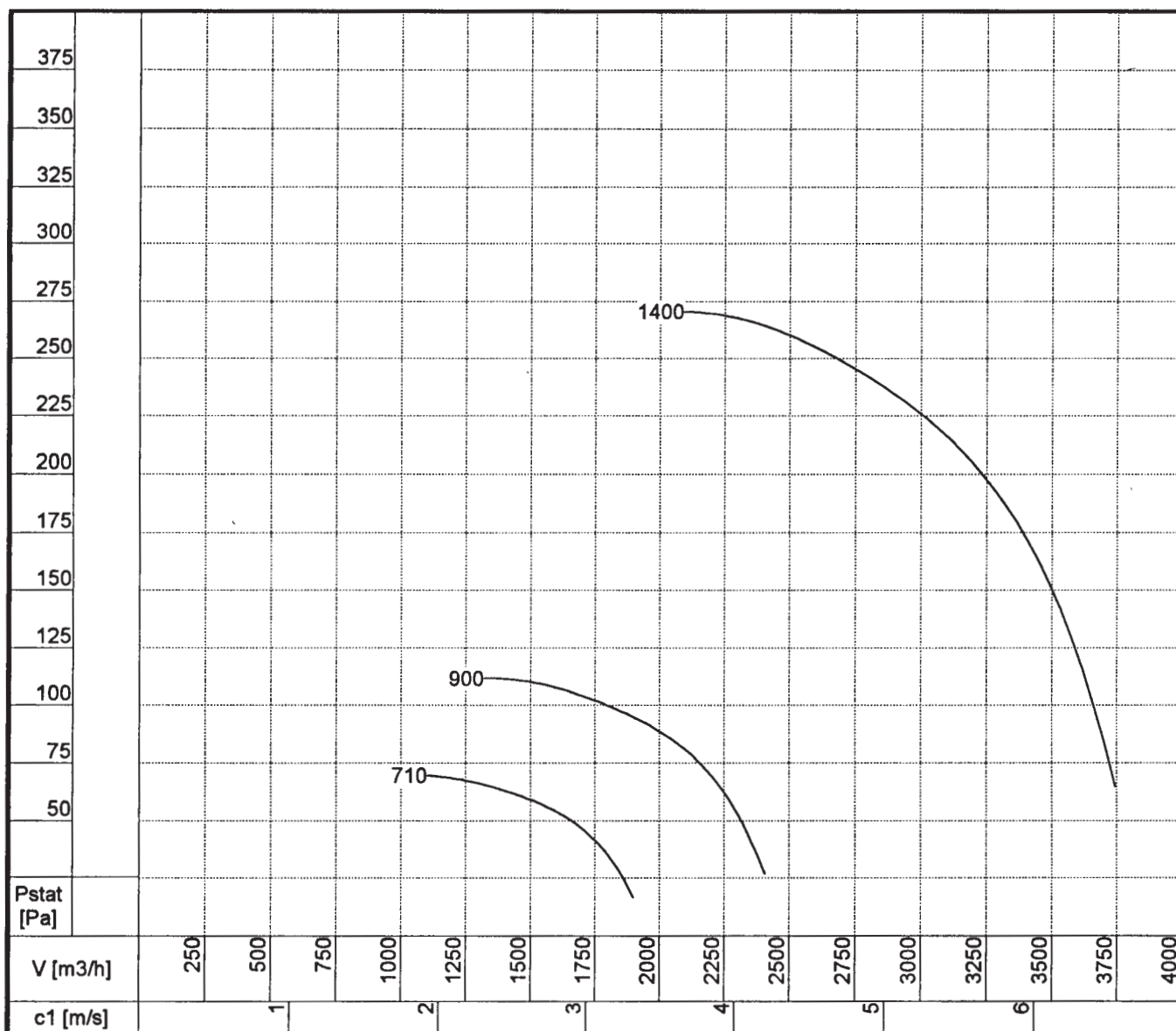

Lydniveau	Lw	dB		Lydtryk		Lp=Lw -7dB		I en afstand på 1m.	
n	Lw	Hz							
min -1	dB	63	125	250	500	1000	2000	4000	8000
700	63	41	50	57	58	57	55	51	47
900	69	47	56	63	64	63	61	57	53
1400	78	56	65	72	73	72	70	66	62

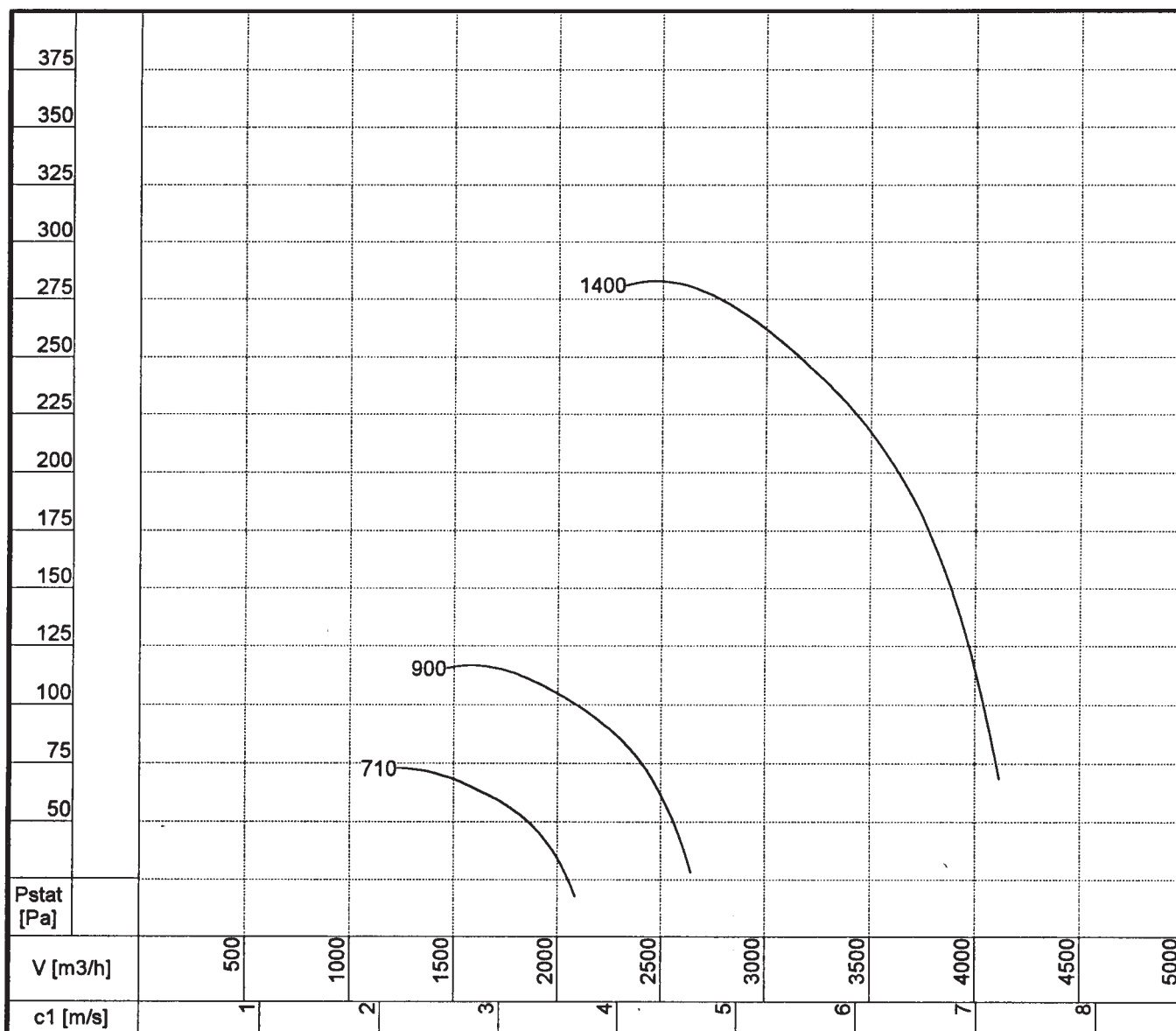

Lydniveau Lw dB Lydtryk Lp=Lw -7dB I en afstand på 1m.

n	Lw	Hz							
min -1	dB	63	125	250	500	1000	2000	4000	8000
700	63	41	50	57	58	57	55	51	47
900	69	47	56	63	64	63	61	57	53
1400	78	56	65	72	73	72	70	66	62

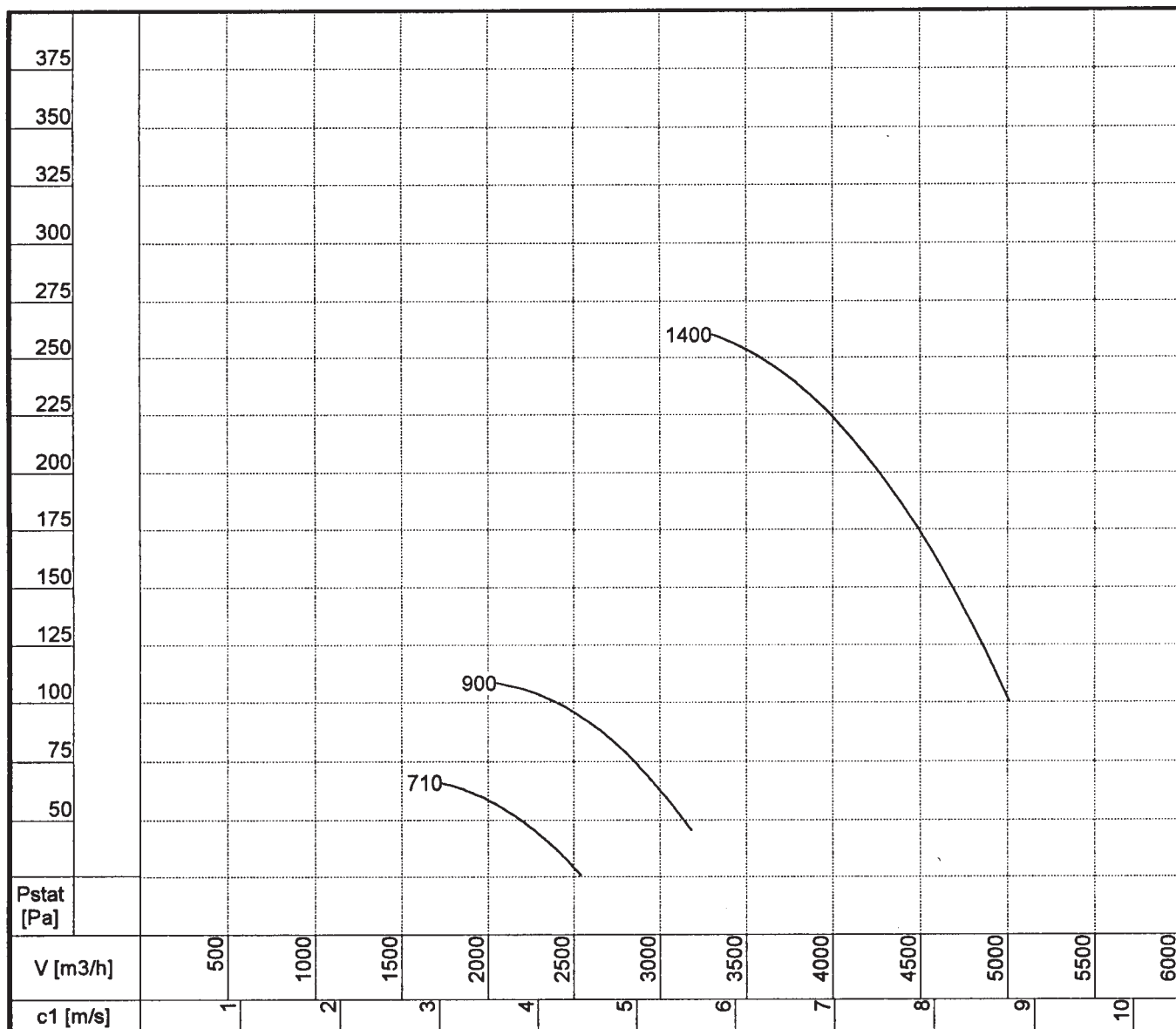

Lydniveau Lw dB Lydtryk Lp=Lw -7dB I en afstand på 1m.

n	Lw	Hz							
min -1	dB	63	125	250	500	1000	2000	4000	8000
700	64	42	51	58	59	57	55	52	48
900	70	48	57	64	65	63	64	58	54
1400	79	57	66	73	74	63	70	67	63

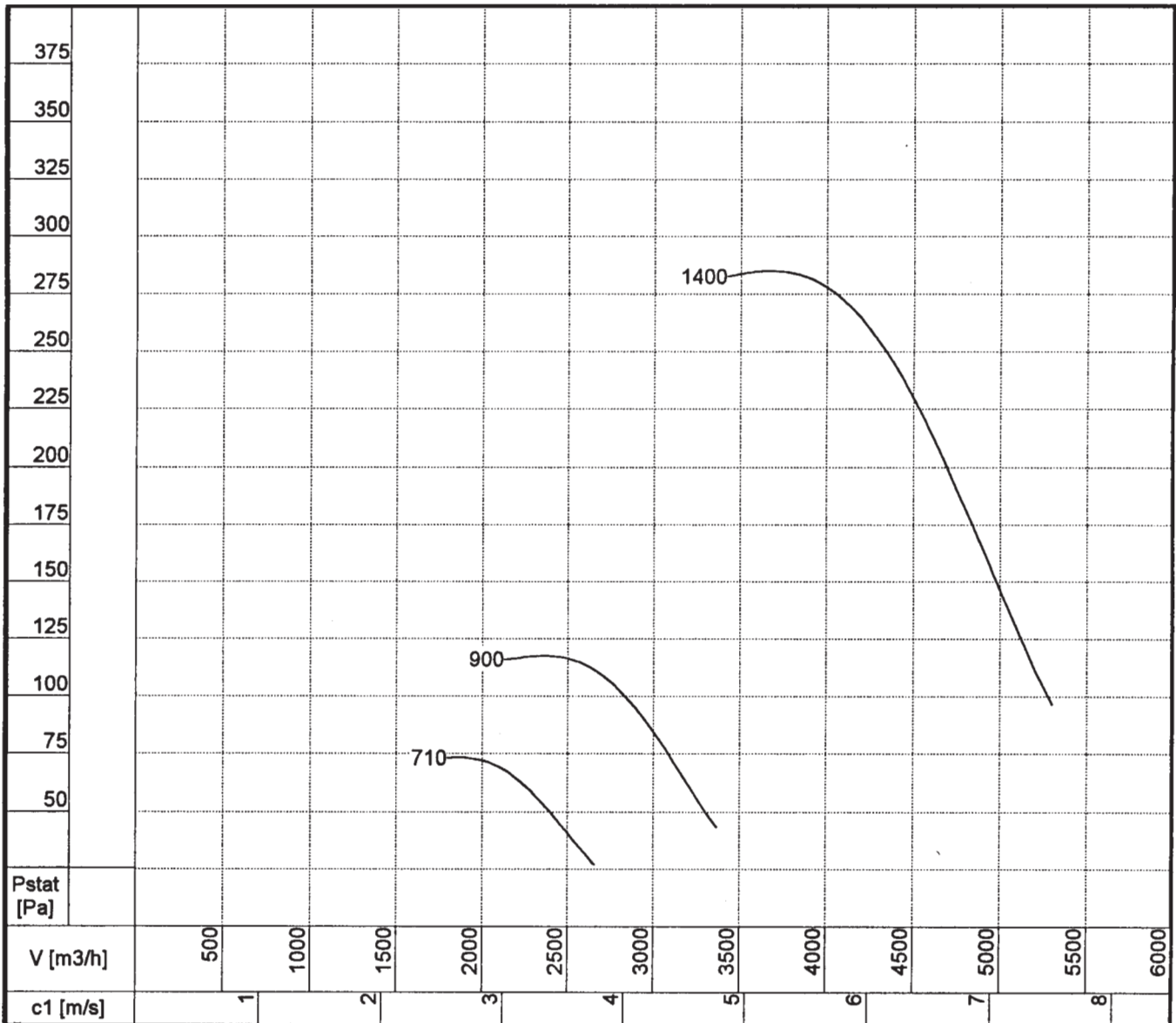

Lydniveau Lw dB Lydtryk Lp=Lw -7dB I en afstand på 1m.

n	Lw	Hz							
min -1	dB	63	125	250	500	1000	2000	4000	8000
700	63	41	50	57	58	57	55	51	47
900	69	47	56	63	64	63	61	57	53
1400	78	56	65	72	73	72	70	66	62

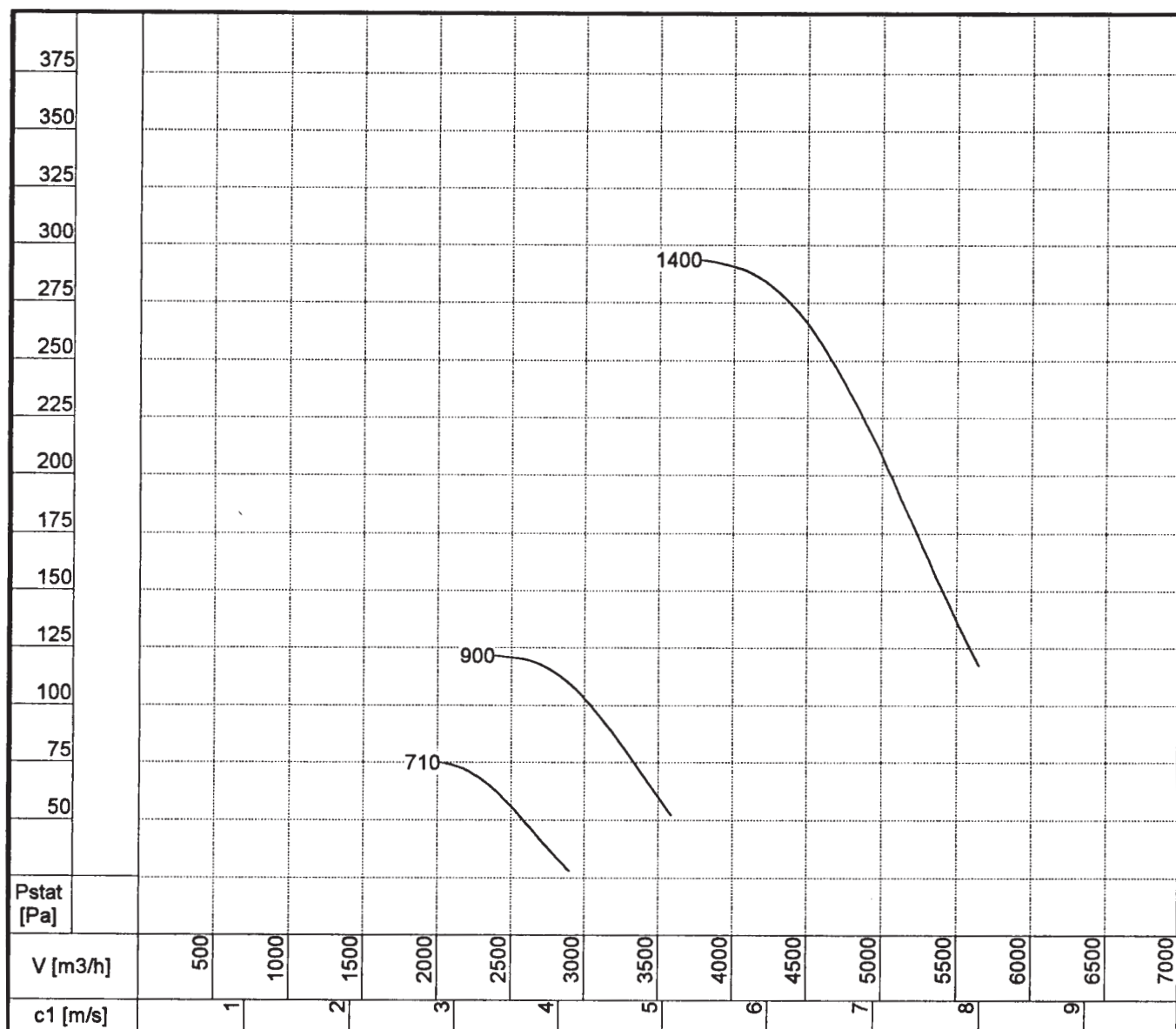

Lydniveau Lw dB Lydtryk Lp=Lw -7dB I en afstand på 1m.

n	Lw	Hz							
min -1	dB	63	125	250	500	1000	2000	4000	8000
700	65	43	52	59	60	57	56	53	49
900	71	49	58	65	66	63	62	59	55
1400	80	58	67	74	75	72	71	68	64

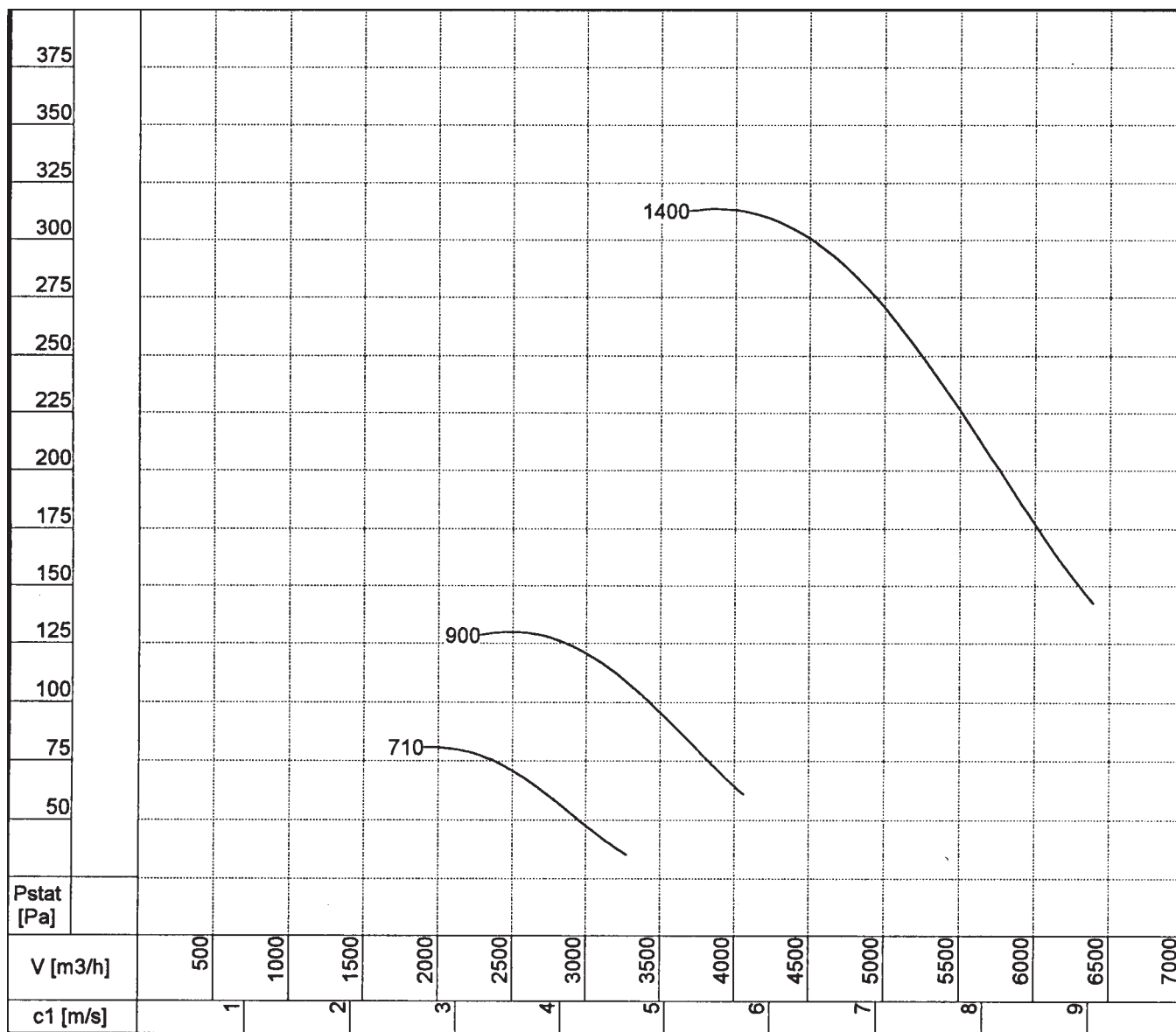

Lydniveau Lw dB Lydtryk Lp=Lw -7dB I en afstand på 1m.

n	Lw	Hz							
min -1	dB	63	125	250	500	1000	2000	4000	8000
700	65	43	52	59	60	59	57	53	49
900	71	49	58	65	66	65	63	59	55
1400	80	58	67	74	75	74	72	68	64

Ydelseskurve for ventilator type

CDVA 560/30

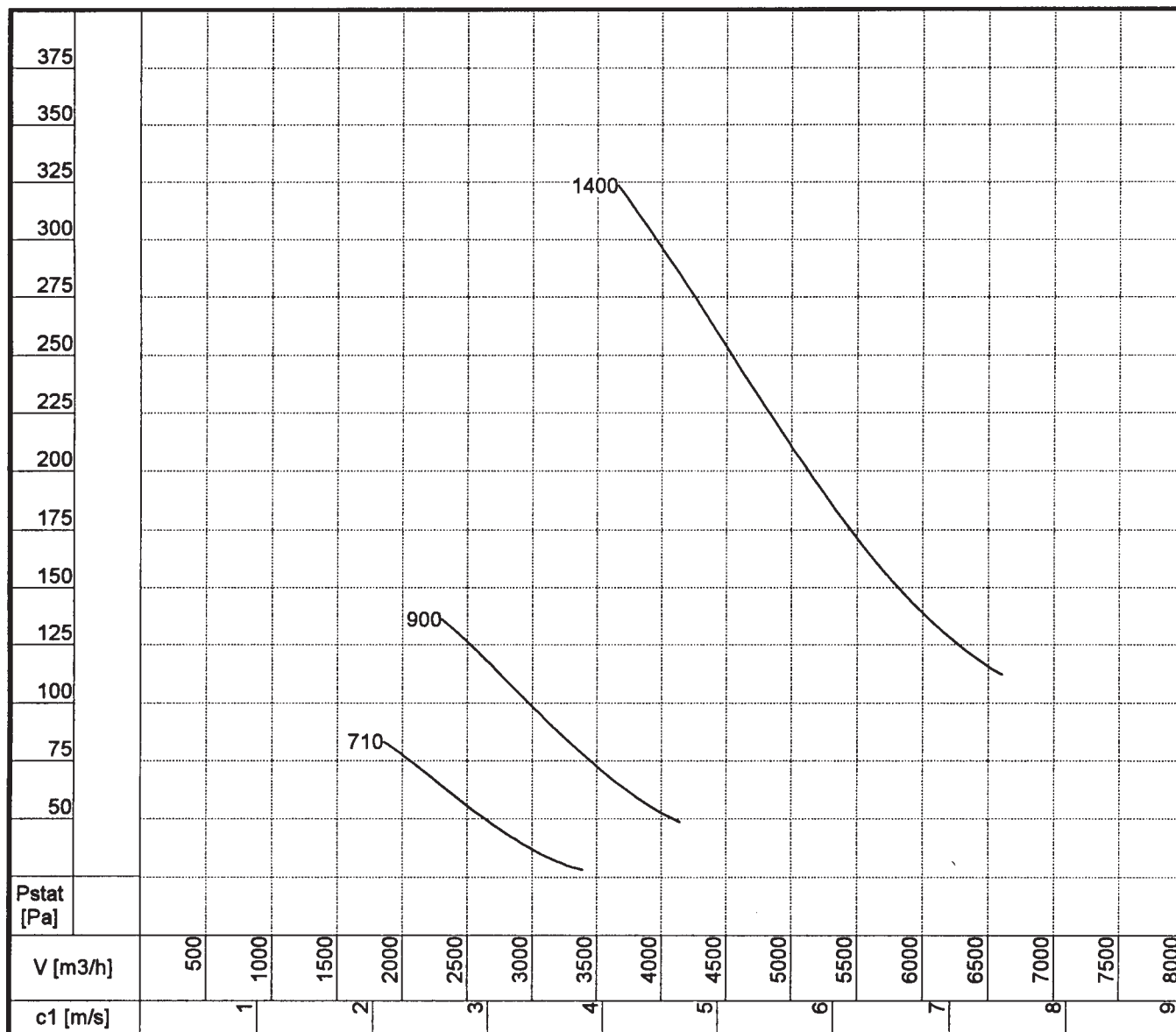

Lydniveau Lw dB Lydtryk Lp=Lw -7dB I en afstand på 1m.

n	Lw	Hz							
min -1	dB	63	125	250	500	1000	2000	4000	8000
700	63	41	50	57	58	57	55	51	47
900	69	47	56	63	64	63	61	57	53
1400	78	56	65	72	73	72	70	66	62

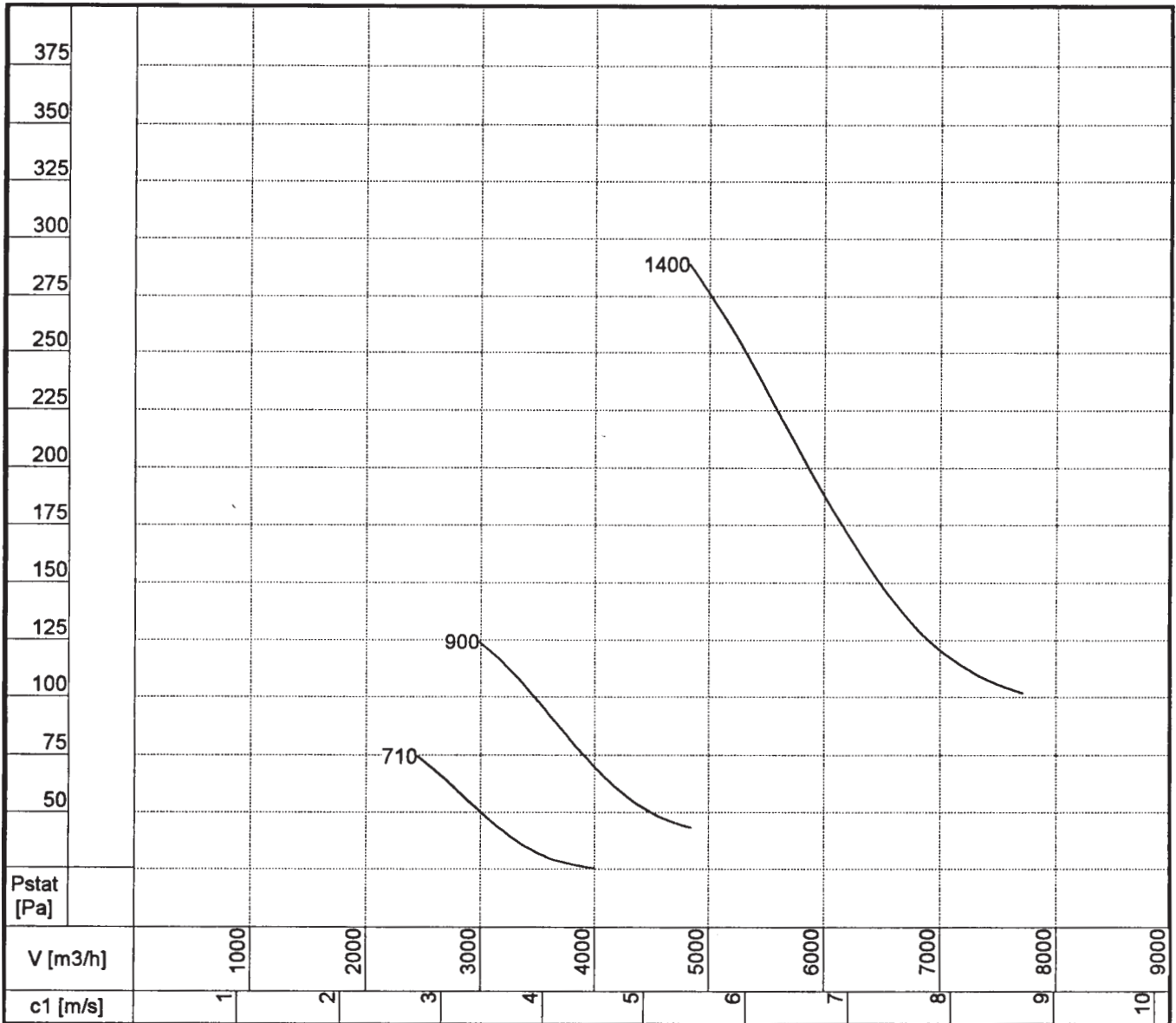

Lydniveau Lw dB Lydtryk Lp=Lw -7dB I en afstand på 1m.

n	Lw	Hz							
min -1	dB	63	125	250	500	1000	2000	4000	8000
700	63	40	50	56	58	56	55	50	46
900	69	46	56	62	64	62	61	56	52
1400	78	55	65	71	73	71	70	65	61

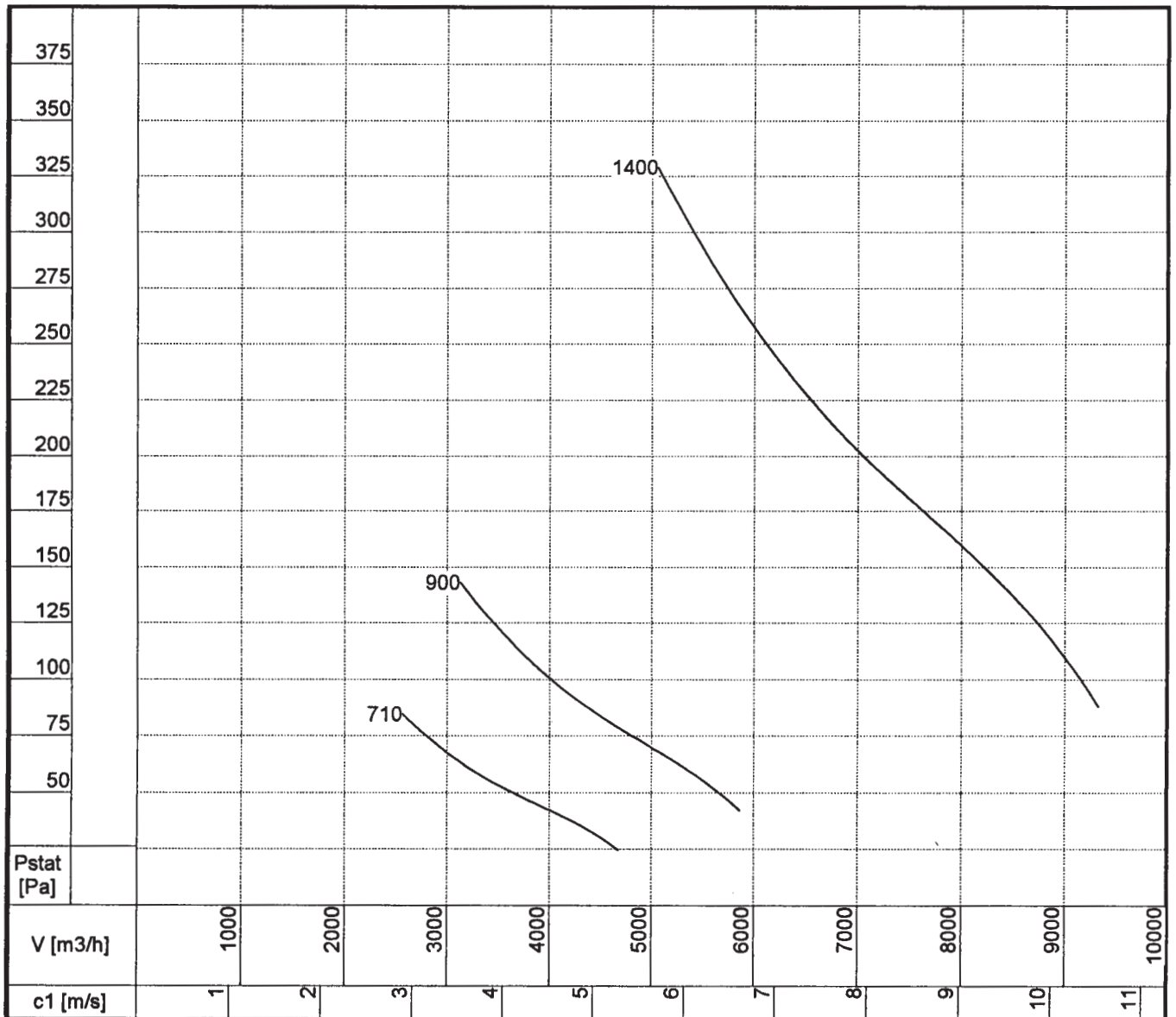

Lydniveau	Lw	dB				Lydtryk	Lp=Lw -7dB	I en afstand på 1m.		
n	Lw	Hz								
min -1	dB	63	125	250	500	1000	2000	4000	8000	
700	66	44	53	59	61	59	58	54	51	
900	72	50	59	65	67	65	64	60	57	
1400	81	59	68	74	76	74	73	69	66	

Ydelseskurve for ventilator type

CDVA 630/30

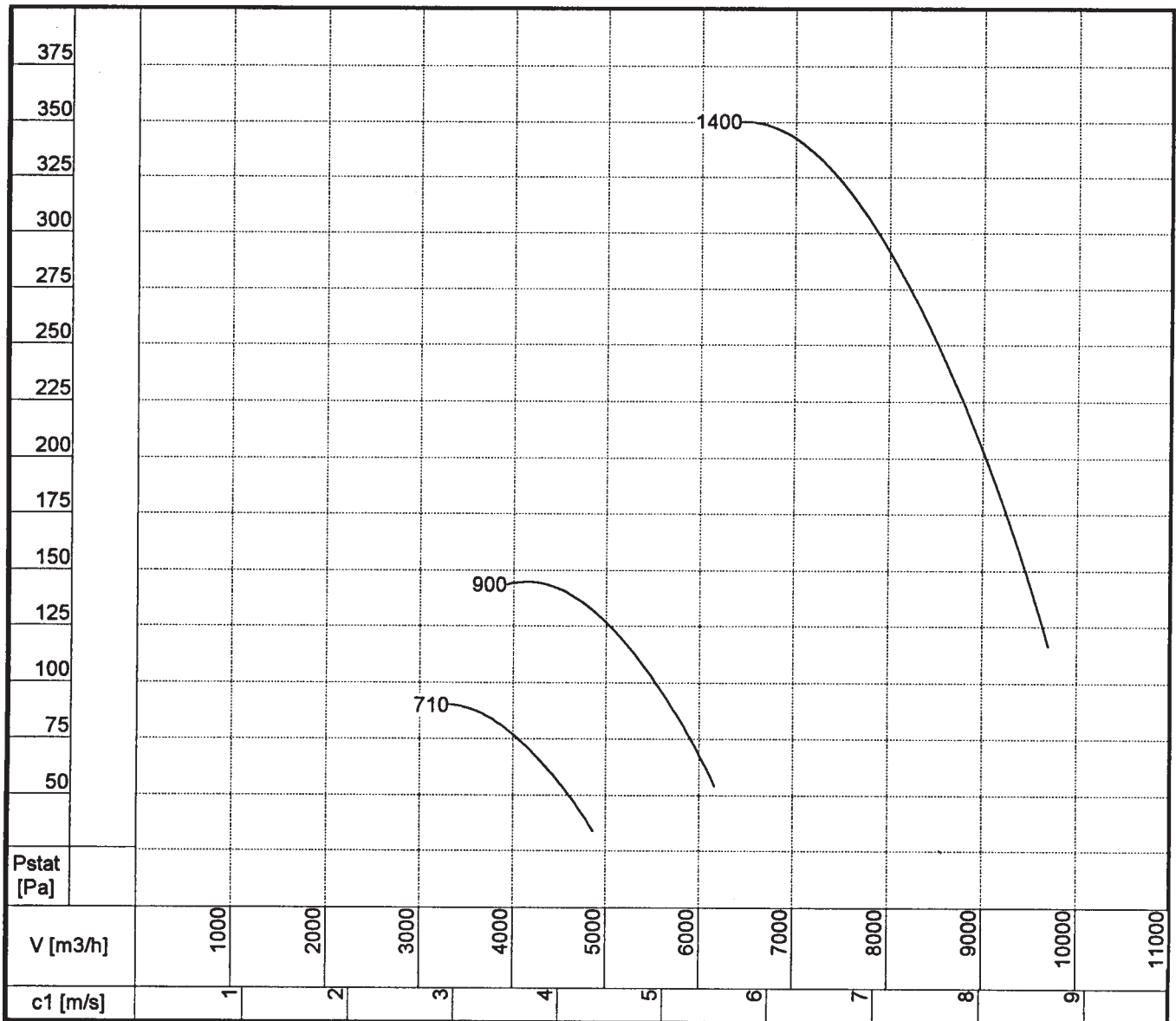

Lydniveau Lw dB Lydtryk Lp=Lw -7dB I en afstand på 1m.

n	Lw	Hz							
min -1	dB	63	125	250	500	1000	2000	4000	8000
700	69	47	56	63	64	62	61	57	53
900	75	53	62	69	70	68	67	63	59
1400	84	62	71	78	79	77	76	72	68

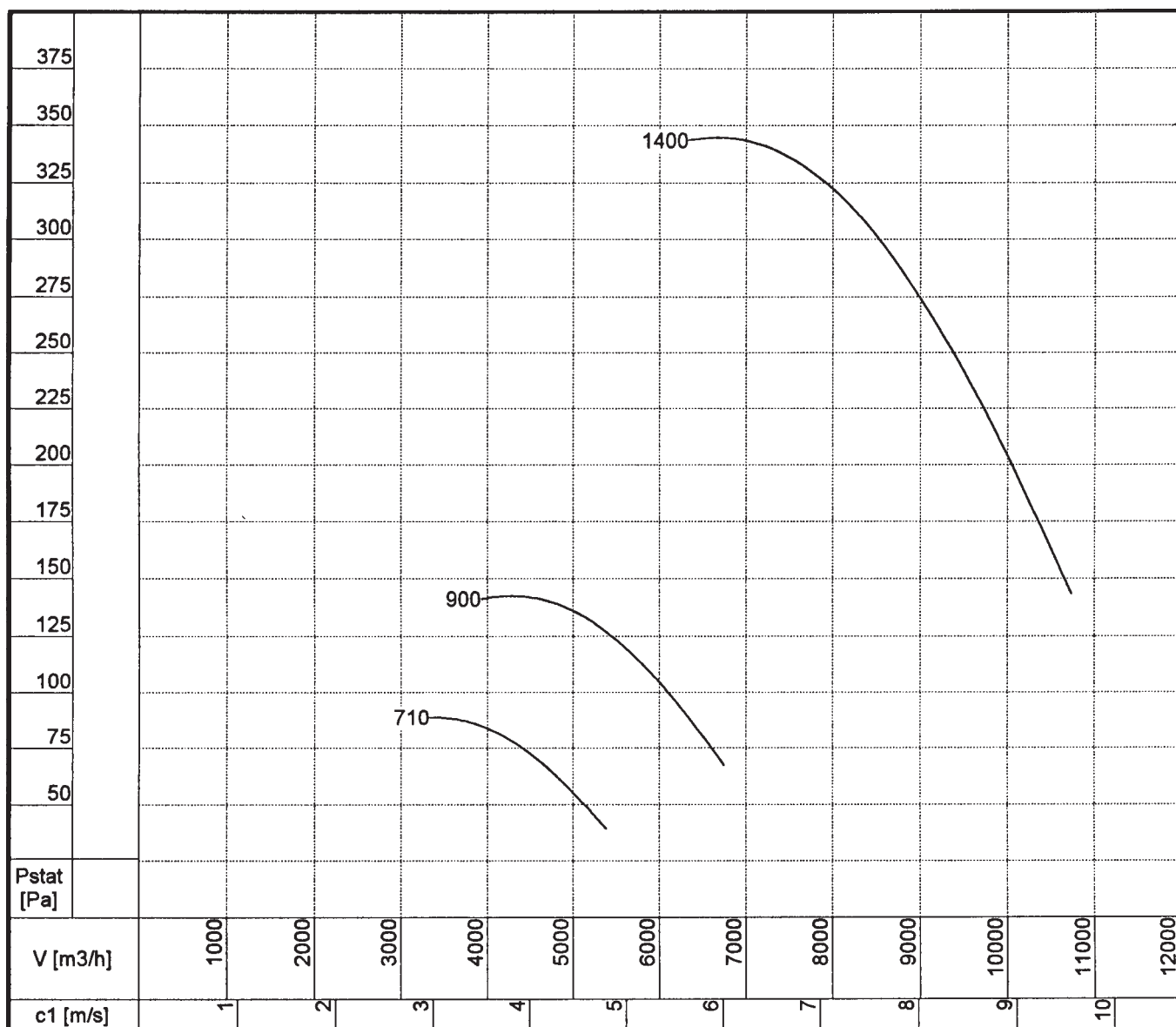

Lydniveau Lw dB Lydtryk Lp=Lw -7dB I en afstand på 1m.

n	Lw	Hz							
min -1	dB	63	125	250	500	1000	2000	4000	8000
700	70	48	57	63	65	63	62	58	54
900	76	54	63	69	71	69	68	64	60
1400	85	63	72	78	80	78	77	73	69

Ydelseskurve for ventilator type

CDVA 630/45

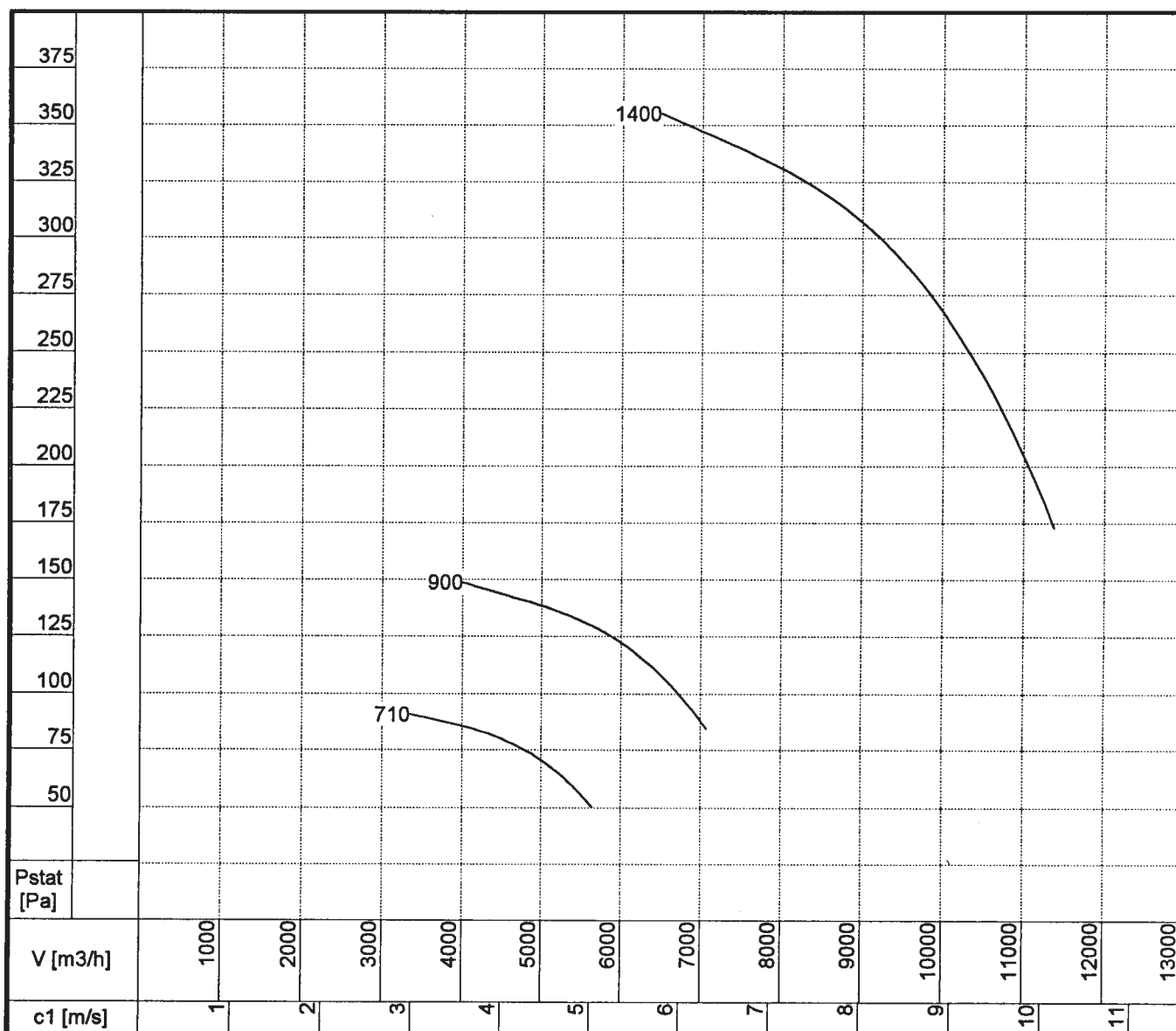

Lydniveau Lw dB Lydtryk Lp=Lw -7dB I en afstand på 1m.

n	Lw	Hz							
min -1	dB	63	125	250	500	1000	2000	4000	8000
700	71	49	58	65	66	65	63	59	55
900	77	55	64	71	72	71	69	65	61
1400	86	64	73	80	81	80	78	74	70

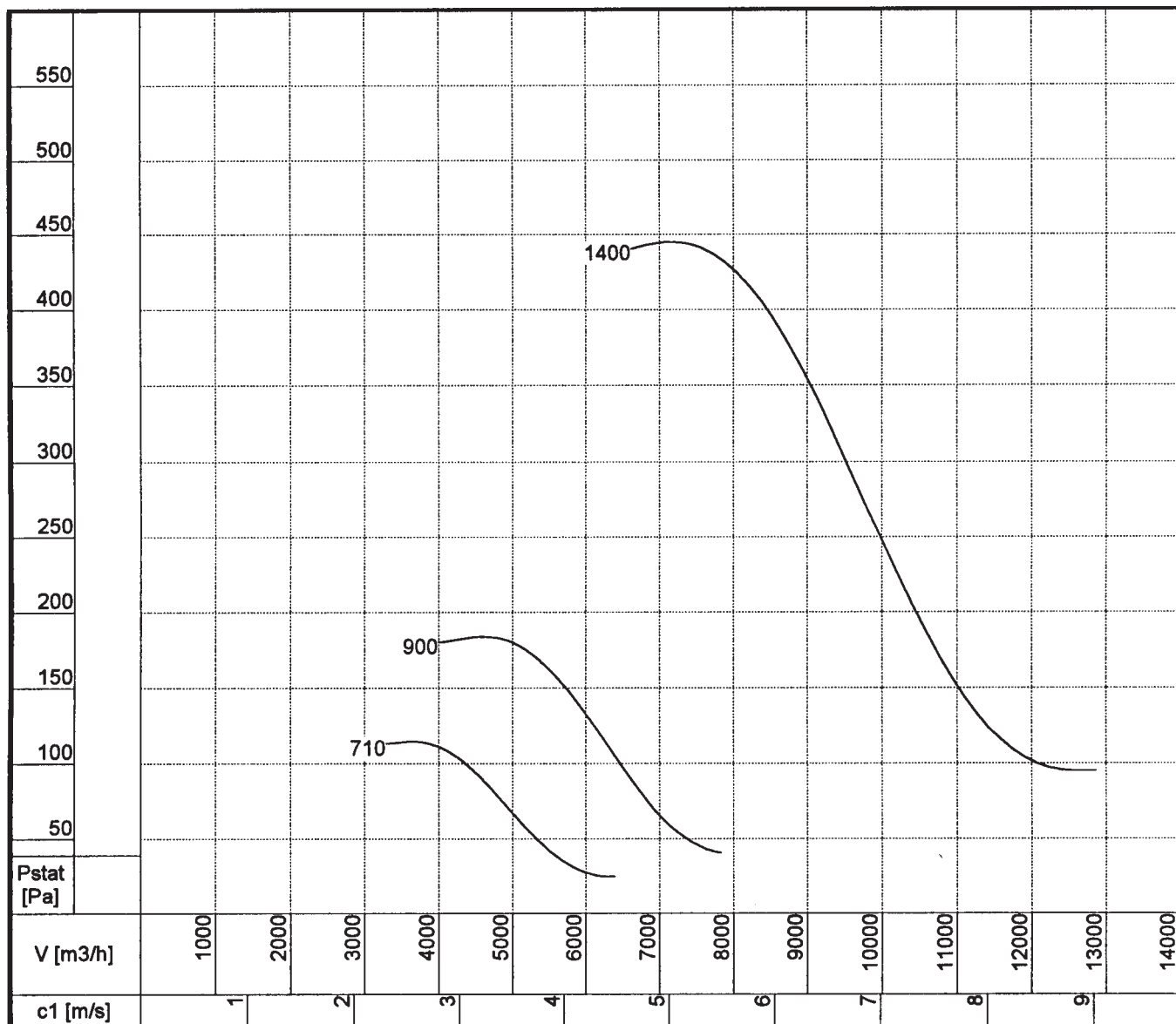

Lydniveau Lw dB Lydtryk Lp=Lw -7dB I en afstand på 1m.

n	Lw	Hz							
min -1	dB	63	125	250	500	1000	2000	4000	8000
700	67	45	54	61	62	61	59	55	51
900	73	51	60	67	68	67	65	61	57
1400	82	60	69	76	77	76	74	70	66

Ydelseskurve for ventilator type

CDVA 710/35

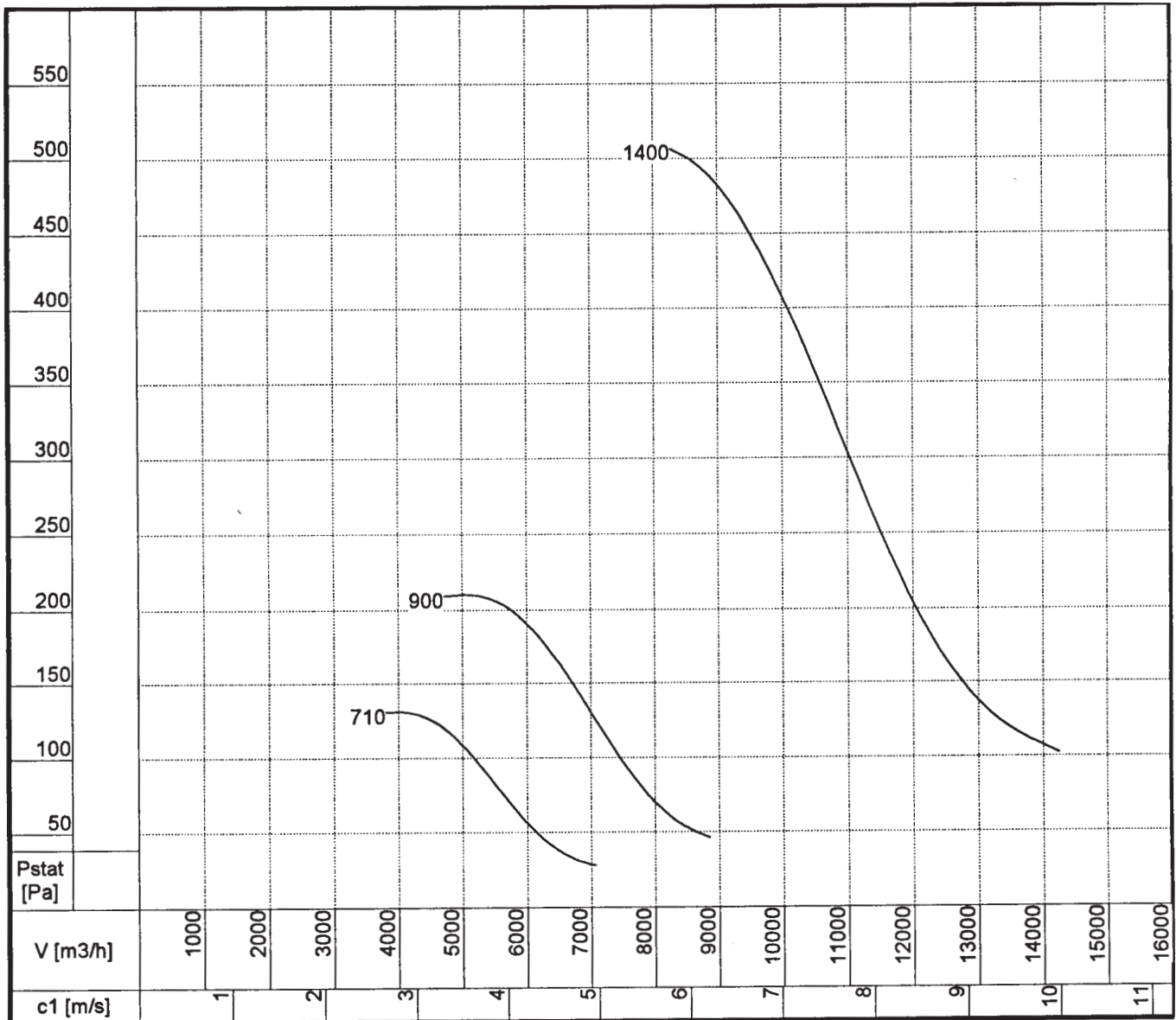

Lydniveau Lw dB Lydtryk Lp=Lw -7dB I en afstand på 1m.

n	Lw	Hz							
min -1	dB	63	125	250	500	1000	2000	4000	8000
700	70	47	57	63	65	63	61	58	53
900	76	53	63	69	71	69	67	64	59
1400	85	62	72	78	80	78	76	73	68

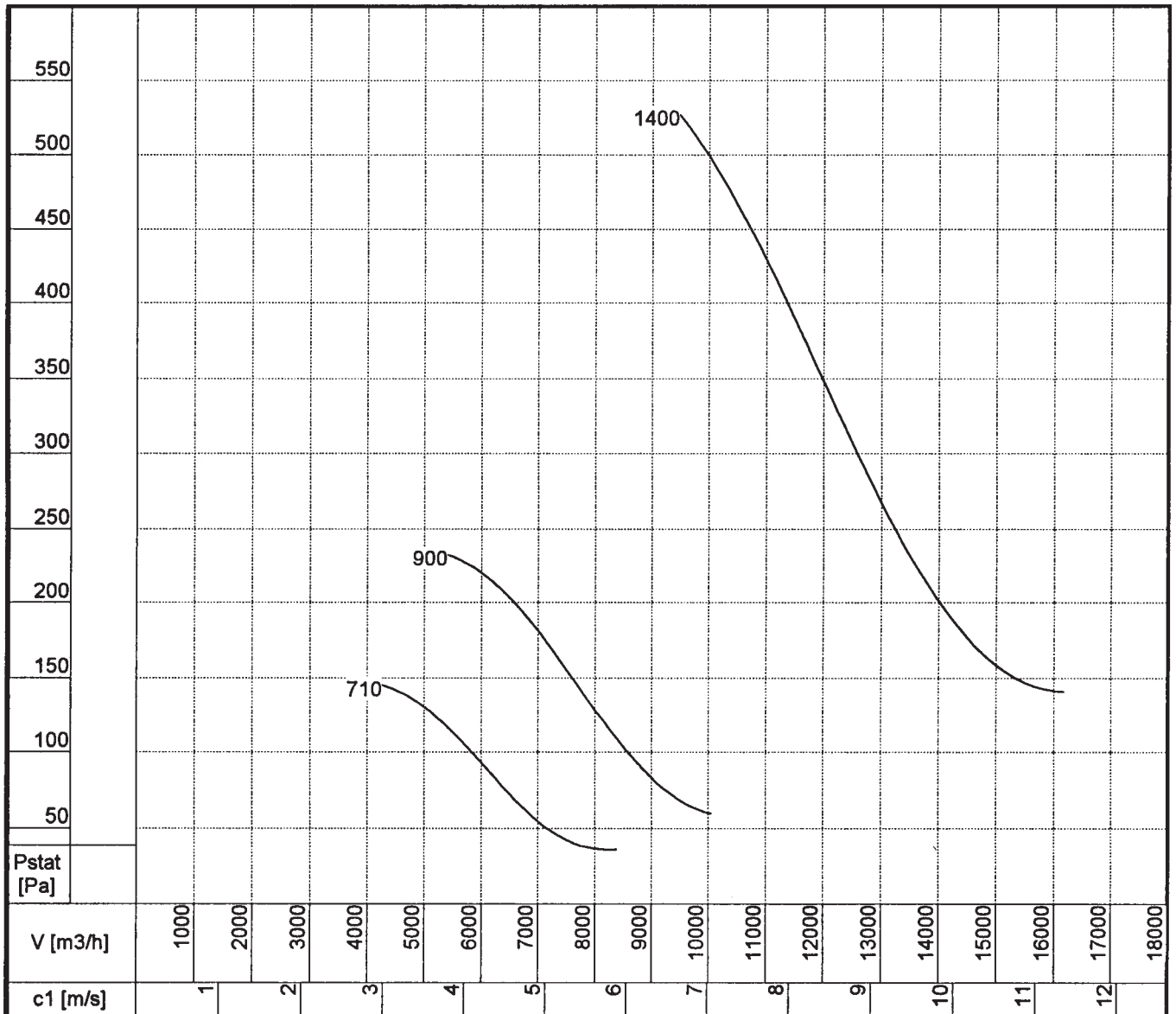

Lydniveau	Lw	dB	Lydtryk				Lp=Lw -7dB				I en afstand på 1m.
n	Lw	Hz	63	125	250	500	1000	2000	4000	8000	
min -1	dB		63	125	250	500	1000	2000	4000	8000	
700	71		49	58	65	66	65	63	59	55	
900	77		55	64	71	72	71	69	65	61	
1400	86		64	73	80	81	80	78	74	70	

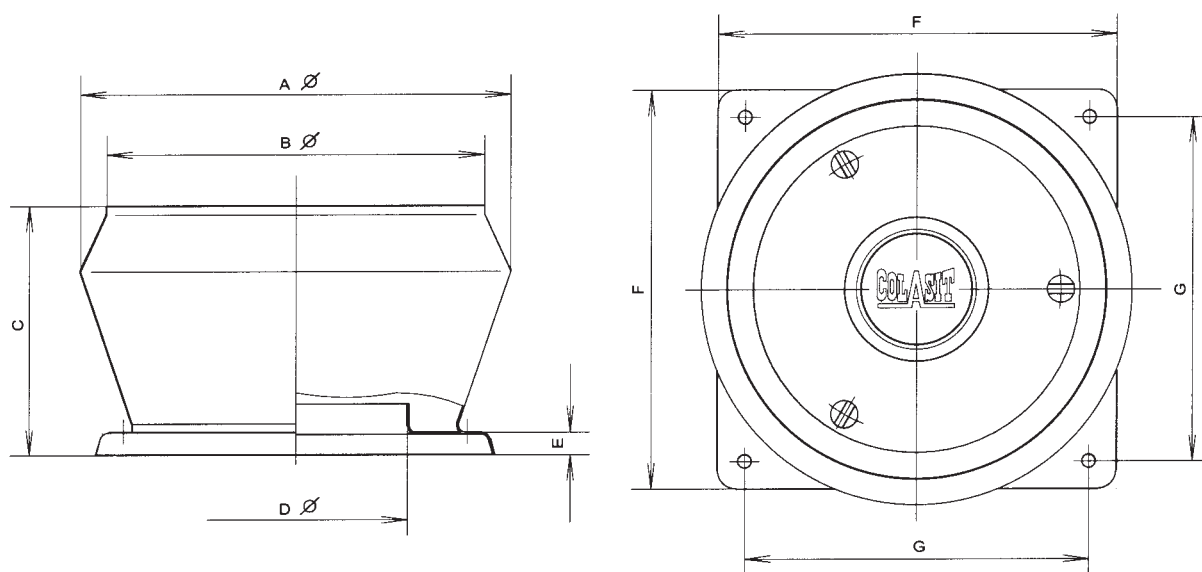

CDVA	400	450	500	560	630	710
A \varnothing	782	782	944	944	1154	1154
B \varnothing	700	700	835	835	980	980
C	440	440	530	530	620	620
D \varnothing	402	452	503	562	633	713
E	50	50	50	50	50	50
F	740	740	877	877	1070	1070
G	620	620	760	760	940	940